

TYVASO DPI[®]
(treprostinil) INHALATION
POWDER

Instructions for Use

TYVASO [tī-vā'-sō] DPI[®]
(treprostinil) Inhalation Powder
For oral inhalation only



Table of Contents

	page(s)
Read Before Starting	1
Important Information	2
Storing TYVASO DPI Inhalers and Cartridges	3
Preparing to Inhale TYVASO DPI	4-7
Inhaling TYVASO DPI	8-9
Removing the Used Cartridge	10
Disposing of TYVASO DPI Cartridge	11
Inhaling Multiple Cartridges of TYVASO DPI	12
Caring for Your TYVASO DPI Inhaler	13
Disposing of Your TYVASO DPI Inhaler	13

Read Before Starting

This Instructions for Use contains information on how to inhale TYVASO DPI (treprostinil) Inhalation Powder. Read this Instructions for Use carefully before you start using your inhaler and each time you get a new inhaler. There may be new information. This information does not take the place of talking to your healthcare provider about your medical condition or your treatment.

Your healthcare provider should show you how to use your inhaler the right way before you use it for the first time.

Parts of the TYVASO DPI Inhaler (see Figure A)

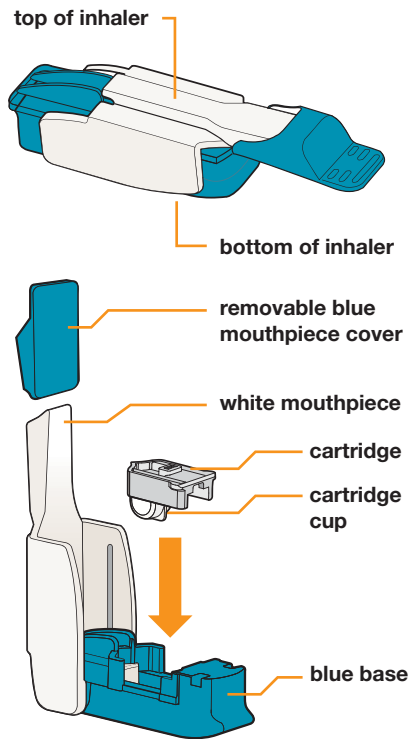

Figure A

Your Starter Kit includes a Carrying Case (see Figure B)

The TYVASO DPI inhaler and blister strips can be stored in the carrying case when using outside of your home or traveling.

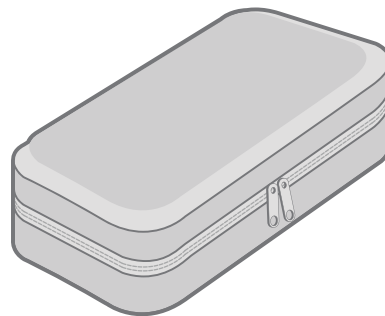
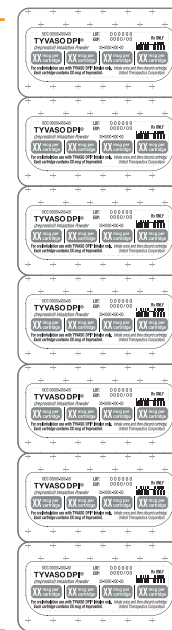

Figure B

TYVASO DPI Blister Cards (see Figure C)

blister card
(7 strips
per blister
card)



strip
(4 cartridges
per strip)

Figure C

Important Information

Important information you need to know before inhaling TYVASO DPI Inhalation Powder using the TYVASO DPI Inhaler

TYVASO DPI cartridges come in 4 strengths (see Figure D).

Important: Always make sure you have the right number of TYVASO DPI cartridges for your dose before you start. Only use TYVASO DPI cartridges with the TYVASO DPI Inhaler.

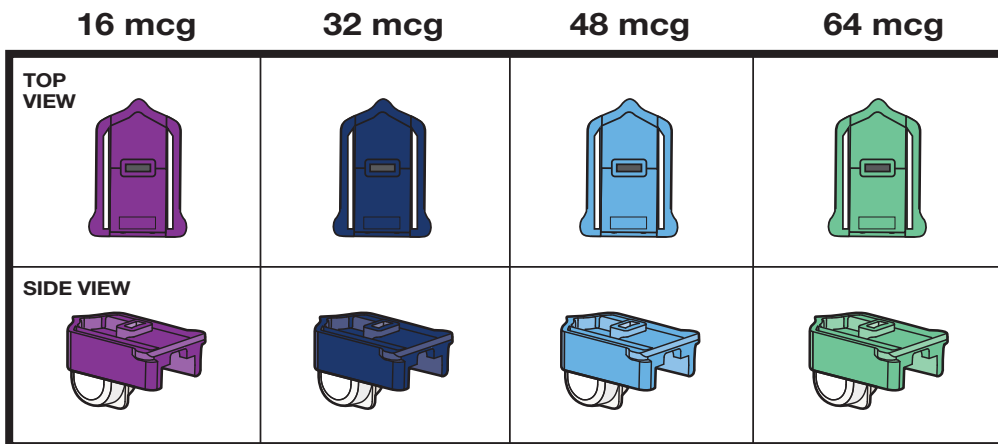

Figure D

If you are having problems with your TYVASO DPI Inhaler, have any side effects, or if your TYVASO DPI Inhaler breaks and you need a new one, please call 1-877-UNITHER (1-877-864-8437).

- Take TYVASO DPI exactly as prescribed by your healthcare provider.
- Take TYVASO DPI 4 times per day while you are awake, about 4 hours apart.
- If you miss a dose, take it as soon as possible at your usual dose.
- If your prescribed dose is higher than 64 mcg per treatment session, you will need to use more than 1 cartridge. If using more than 1 cartridge, the cartridges can be used in any order, regardless of cartridge strength.
- If you need to use more than 1 cartridge for your dose, remove the used cartridge from the inhaler before getting a new one. You can tell a cartridge has been used when the cartridge cup has moved from the front to the middle position in the cartridge base.
- **Only TYVASO DPI cartridges should be used with the TYVASO DPI Inhaler.**
- **Each cartridge is for 1 time (single use) only.** Use a new cartridge for each treatment session. After each treatment session, throw away the used cartridge right away.
- **Do not** open the cartridges. The inhaler opens the cartridge automatically during use.
- **Warning:** If any powder from the cartridge spills on your hands, throw away the cartridge right away into regular household trash and wash your hands. Then start with a new cartridge.
- **Do not** breathe in the TYVASO DPI treprostinil powder in any other way.
- **Do not** put cartridges in your mouth.
- **Do not** swallow cartridges.
- Use only 1 inhaler at a time. The same inhaler should be used even when needing to use more than 1 cartridge for your dose. Inhale 1 cartridge at a time.
- The inhaler lasts for 7 days. After 7 days of use, throw away your used inhaler and get a new one.
- Store the inhaler in a clean, dry place with the mouthpiece cover on until your next dose.

Storing TYVASO DPI Inhalers and Cartridges

Storing TYVASO DPI Inhalers

Store TYVASO DPI Inhalers, with the mouthpiece on, in a clean, dry place at room temperature between 68°F to 77°F (20°C to 25°C), such as a drawer or medicine cabinet (see **Figure E**).

Inhalers may be stored in the refrigerator between 36°F to 46°F (2°C to 8°C), but should be left out at room temperature for 10 minutes before use.

Do not leave or store cartridges in the inhaler.

Keep out of the reach of children.

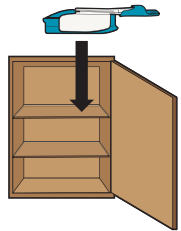

Figure E

Storing Unopened Blister Cards and Strips

Store unopened blister cards and strips in a clean, dry place at room temperature, such as a drawer or medicine cabinet. You can store in the carrying case when using outside your home or traveling (see **Figure F**).

Do not use after 8 weeks if stored at room temperature.

Unopened blister cards and strips may also be stored in the refrigerator (see **Figure G**).

Do not use after the Expiration Date has passed.

Important: If refrigerated, cartridges and inhaler should be left out at room temperature for 10 minutes before use.

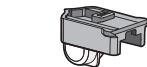

ROOM TEMPERATURE



10 mins.

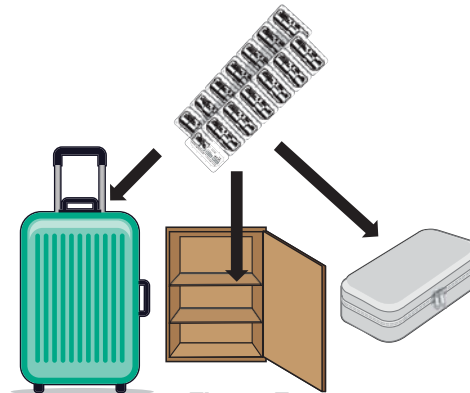

Figure F

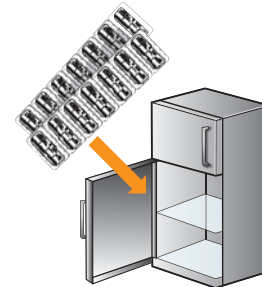

Figure G

Storing Opened Blister Strips

Store opened blister strips in a clean, dry place at room temperature (see **Figure H**), such as a drawer or medicine cabinet.

Opened blister strips must be used within 3 days.

Do not put a blister strip back into the refrigerator after being opened or stored at room temperature.

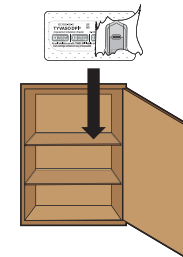

Figure H

Preparing to Inhale TYVASO DPI

Step 1: Select the TYVASO DPI cartridges for your dose (see Figure I)

Select the TYVASO DPI cartridges for your dose (see **Figure I**).

Note: If using more than 1 cartridge, the cartridges can be used in any order, regardless of cartridge strength.

If your prescribed TYVASO DPI dose is 16 mcg, use...

1 purple cartridge.

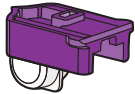

If your prescribed TYVASO DPI dose is 32 mcg, use...

1 dark blue cartridge.

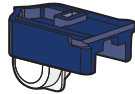

If your prescribed TYVASO DPI dose is 48 mcg, use...

1 light blue cartridge.

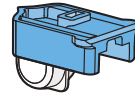

If your prescribed TYVASO DPI dose is 64 mcg, use...

1 light green cartridge.

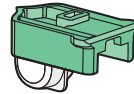

If your prescribed TYVASO DPI dose is more than 64 mcg per treatment session, you will need to use more than 1 cartridge to get the right dose.

Example: If your prescribed TYVASO DPI dose is 80 mcg per treatment session, you can use...

1 dark blue cartridge (32 mcg)

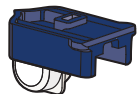

1 light blue cartridge (48 mcg)

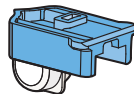

Figure I

Step 2: Tear off 1 strip

Tear along the perforation to remove 1 strip from the blister card (see **Figure J**).

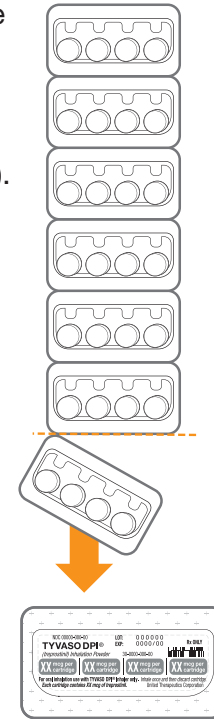

Figure J

Step 3: Check the expiration date on the strip

Check the expiration date on the foil strip label (see **Figure K**).

Do not use the cartridges if the Expiration Date on the strip has passed.

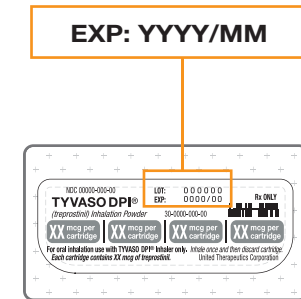

Figure K

Preparing to Inhale TYVASO DPI (continued)

Step 4: Remove cartridge(s) from strip

- Remove cartridge(s) from the strip by pushing on the white plastic to push the cartridge out (see **Figure L**).

Note: Pushing on the cup will not damage the cartridge.

- Make sure to remove the right number of cartridges for your dose.
- After you have removed a cartridge (or cartridges) from the strip, if any unused cartridges remain in the strip, store the strip at room temperature.

Do not put a blister strip back into the refrigerator after being opened.

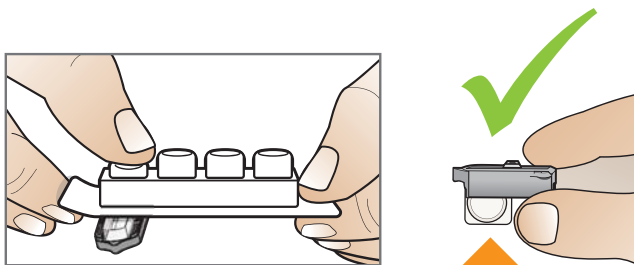
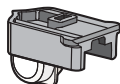

Figure L

Important: If refrigerated, cartridges and inhaler should be left out at room temperature for 10 minutes before use.



ROOM TEMPERATURE



10 mins.

Step 5: Check supplies before continuing



Check that you have the right cartridge(s) for your dose.



Only use one inhaler for multiple cartridges. Your inhaler lasts for 7 days.

Preparing to Inhale TYVASO DPI (continued)

Step 6: Load a cartridge

Place Inhaler on Flat Surface

Place the inhaler on a flat surface (see **Figure M**).

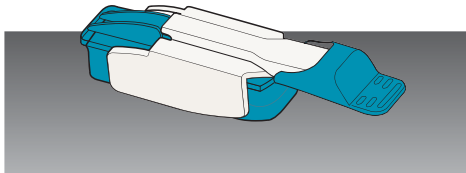

Figure M

Open Inhaler

Open the inhaler by lifting the mouthpiece to an upright (vertical) position (see **Figure N**).

Important: If the cartridge came from a strip stored in the refrigerator (or if you stored the inhaler in the refrigerator), leave the cartridge and inhaler at room temperature for 10 minutes to remove condensation.



10 mins.

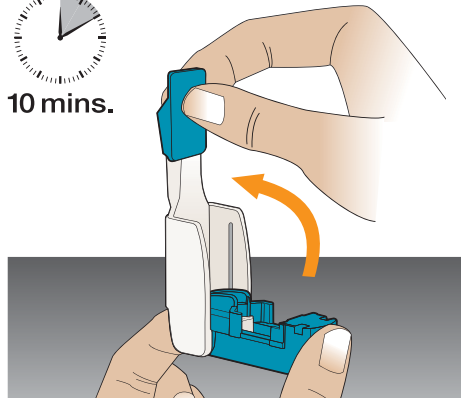

Figure N

Place Cartridge in Inhaler

- Hold the cartridge with the cup facing down (see **Figure O**).
- Line up the cartridge with the opening in the inhaler. The pointed end of the cartridge should line up with the pointed end in the inhaler (see **Figure P**).
- Place the cartridge into the inhaler so that it lies flat.

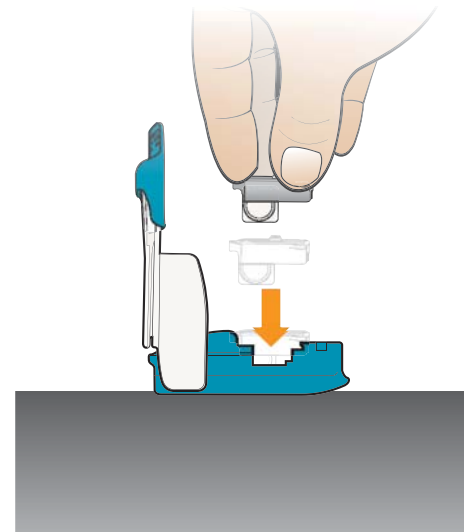

Figure O

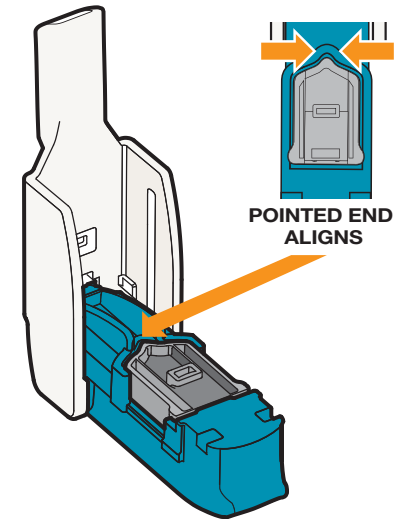

Figure P

Preparing to Inhale TYVASO DPI (continued)

Step 6: Load a cartridge (continued)

Close Inhaler

Close the inhaler (this will open the cartridge). You should feel a snap when the inhaler is closed (see **Figure Q**).

Important: Now that the cartridge is loaded, keep the inhaler level to avoid loss of the TYVASO DPI powder, until it is in your mouth (see **Figure R**).

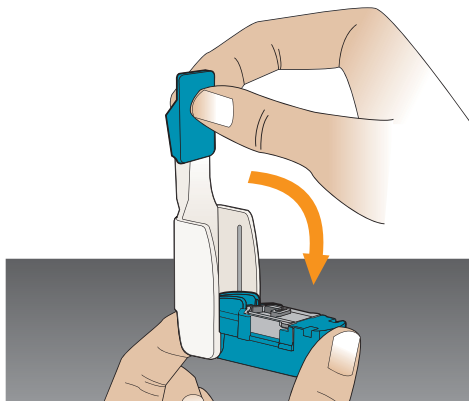

Figure Q

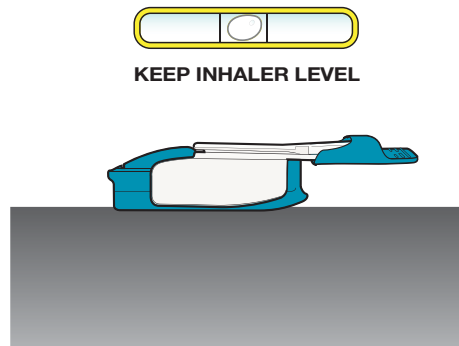
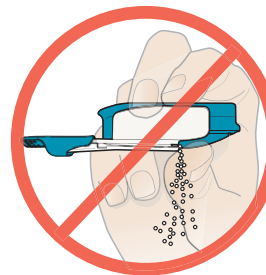

Figure R

Not keeping the inhaler level could cause a loss of TYVASO DPI powder (see Figure S)

If any powder from the cartridge spills:

- Wash your hands right away if the powder comes into contact with your hands,
- Throw away the cartridge into household trash, and
- Repeat Steps 4, 5, and 6 to load a new cartridge



DO NOT turn inhaler upside down.

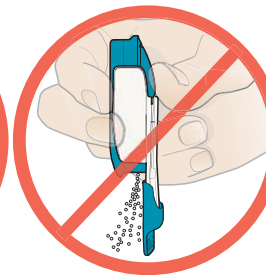

DO NOT point the mouthpiece down.

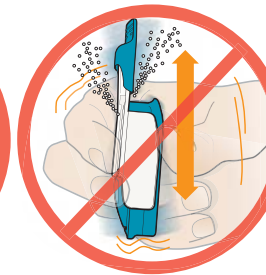

DO NOT shake or drop the inhaler.

This can cause a loss of TYVASO DPI powder.

Figure S

Inhaling TYVASO DPI

Before inhaling TYVASO DPI, fully review all parts of Step 7 before you take your dose.

Step 7: Inhale Your Dose

Remove the Mouthpiece Cover

Cover (see **Figure T**).

Important: Keep the inhaler level during and after removal of the blue mouthpiece cover to prevent loss of TYVASO DPI powder.

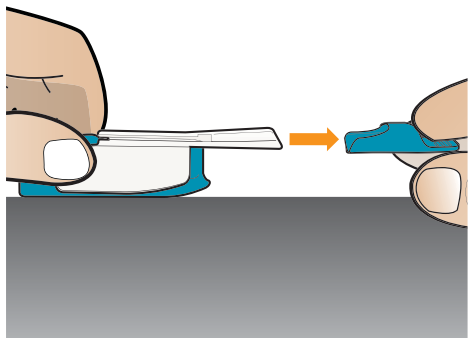

Figure T

Hold Inhaler Near Cheek

While keeping the inhaler level, carefully pick up the inhaler and bring it near your cheek, but not in front of your mouth (see **Figure U**).

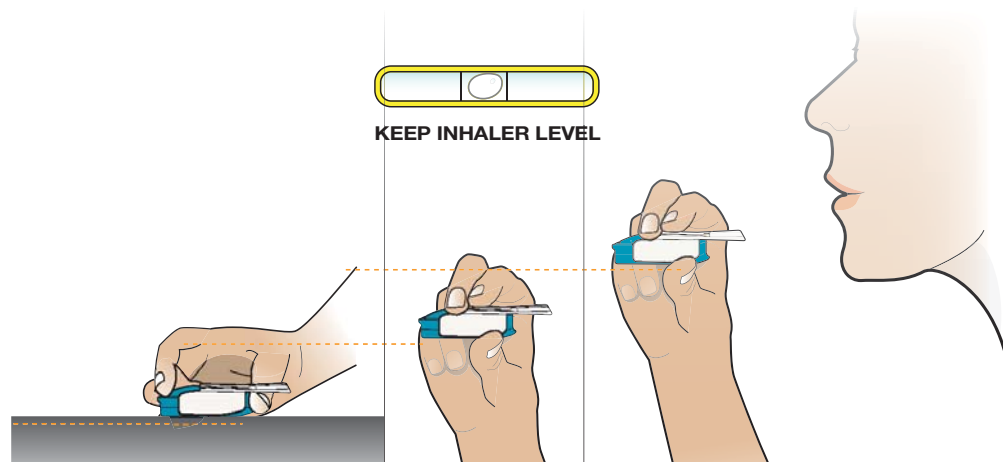

Figure U

Exhale

Holding the inhaler away from your mouth, fully blow out (exhale) (see **Figure V**).

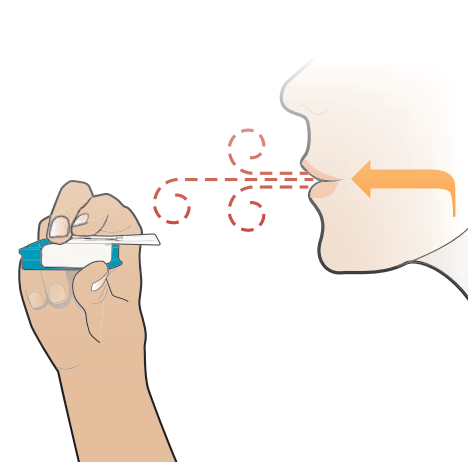

Figure V

Inhaling TYVASO DPI (continued)

Step 7: Inhale Your Dose (continued)

Position Inhaler in Mouth

- Keeping your head level, place the mouthpiece in your mouth and close your lips around the mouthpiece to form a seal.
- Tilt the inhaler slightly downward while keeping your head level (see **Figure W**).

Note: This helps prevent the powder from being blocked by your tongue.

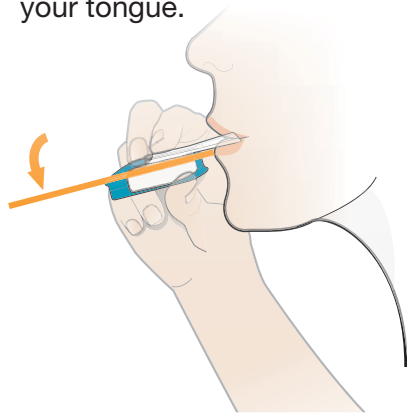

Figure W

Inhale Deeply, Hold Breath, then Exhale

- With your mouth closed around the mouthpiece, **inhale** deeply through the inhaler (see **Figure X**).
- Then remove the inhaler from your mouth and **hold your breath** for as long as you comfortably can (see **Figure Y**).
- Then **blow out** (exhale) and continue to breathe normally (see **Figure Z**).

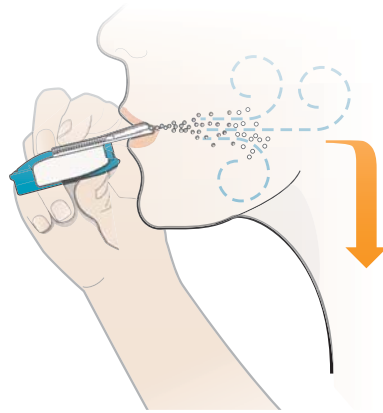

Figure X

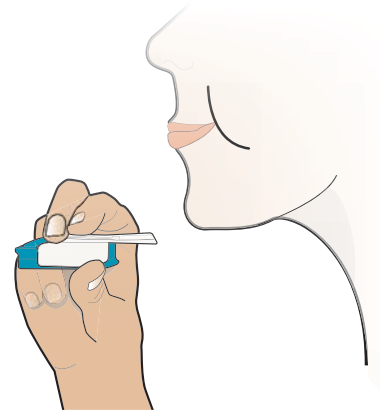

Figure Y

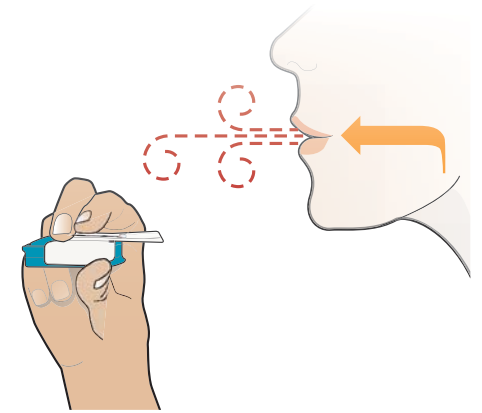

Figure Z

Removing the Used Cartridge

Step 8: Remove the used cartridge

Replace Mouthpiece Cover

Place the mouthpiece cover back onto the inhaler (see **Figure AA**).

Note: This keeps your fingers off the exposed mouthpiece.

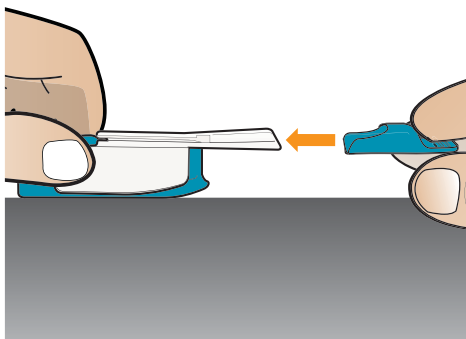

Figure AA

Open Inhaler

Open the inhaler by lifting up the mouthpiece to an upright (vertical) position (see **Figure AB**).

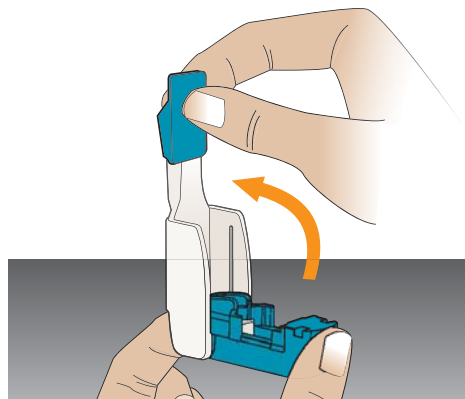

Figure AB

Remove Cartridge

- Remove the used cartridge from the blue base (see **Figure AC**).
- The cup should now be in the middle of the used cartridge (see **Figure AD**).

Warning: If any powder from the cartridge spills on your hands, wash your hands right away.

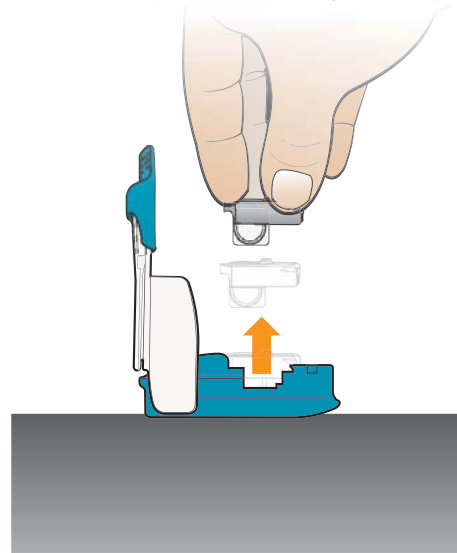

Figure AC

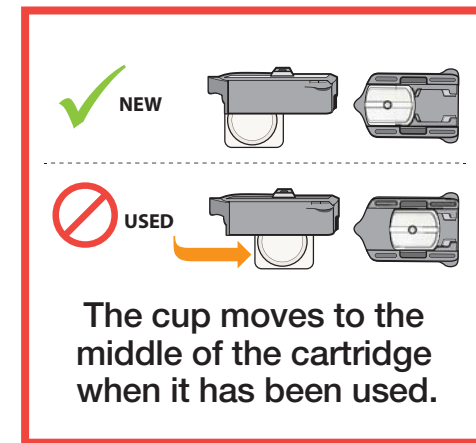

Figure AD

Disposing of TYVASO DPI Cartridges

Step 9: Throw away used cartridge

Throw away the used cartridge in your regular household trash (see **Figure AE**).

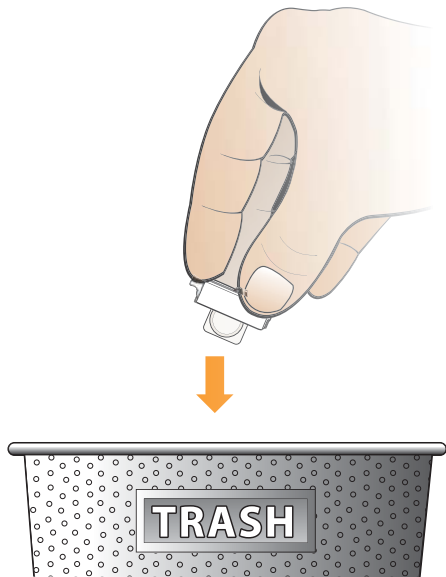

Figure AE

Inhaling Multiple Cartridges of TYVASO DPI

Step 10: Inhaling multiple cartridges (skip if not needed)

If your dose requires you to inhale multiple cartridges, **repeat steps 6 through 9** for each cartridge.

Example: If your prescribed TYVASO DPI dose is 80 mcg per treatment session, you can use one 32 mcg cartridge and one 48 mcg cartridge (see **Figure AF**):

1 dark blue cartridge
(32 mcg)

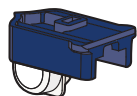

1 light blue cartridge
(48 mcg)

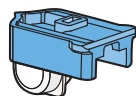

Figure AF

Warning: Be careful not to mix NEW cartridges with used cartridges (see **Figure AG**).

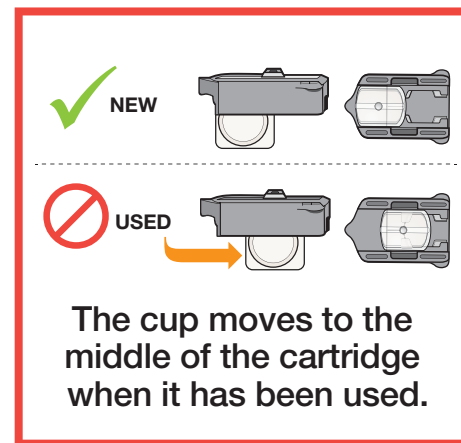

Figure AG

Caring for Your TYVASO DPI Inhaler

Inhaler Care Instructions

Cleaning

After taking your dose, powder residue in the mouthpiece is normal; this will not affect your dose.

The outside of the inhaler can be wiped with a clean, dry cloth only, if needed.

Never wash the inhaler.

Always keep the inhaler dry.

Use Time

Only use 1 inhaler at a time. The same inhaler can be used to take 16 mcg, 32 mcg, 48 mcg, or 64 mcg cartridges.

Replace the inhaler after 7 days (see **Figure AH** and **Figure AI**). Keep track of 7 days from when you start using the inhaler with a calendar.

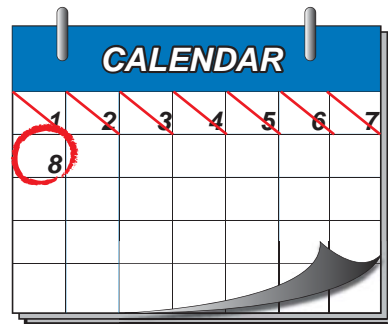

**REPLACE
AFTER 7 DAYS**

Figure AH

Disposing of Your TYVASO DPI Inhaler

Throw away used inhaler after 7 days of use

After 7 days of use, throw away the used inhaler in your regular household trash (see **Figure AH** and **Figure AI**).

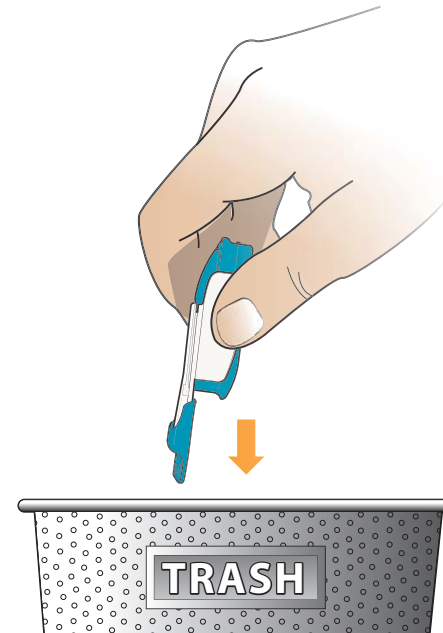

Figure AI

For further questions and information, or to report a problem with your device or any side effects with your TYVASO DPI, please call 1-877-UNITHER (1-877-864-8437).

This Instructions for Use has been approved by the U.S. Food and Drug Administration.

Revised: November 2023

TYVASO DPI® is a registered trademark of United Therapeutics Corporation.

Patents: www.tyvasodpi.com/patent



Distributed by:

United Therapeutics Corporation
Research Triangle Park, NC 27709
USA

Manufactured by:

MannKind Corporation
Danbury, CT 06810
USA

11/2023 30-1311-006-02